

FBL4200 Series

FBL4200 Flap Barrier Turnstile for additional Lane

FBL4211 Flap Barrier Turnstile for additional Lane
(w/ controller and RFID reader)

FBL4222 Flap Barrier Turnstile for additional Lane
(w/ controller and fingerprint & RFID reader)

The ZKTeco FBL4200 dual lane flap barrier turnstile is an elegant cost-effective entrance control system designed for high-traffic volume. The FBL4200 series should work together with FBL4000 series to build multiple lanes.

The FBL4200 is a Flap Barrier Turnstile for additional Lane series designed for smooth and silent operation and draws very little power. It's made of stainless steel which makes FBL4200 highly durable.

FBL4200 barriers are normally held in a locked position, thus denying access to the secured side. Upon FBL4200's reader (RFID and/or fingerprint) positively recognizing a user's valid access card or fingerprint, its barriers retract upward automatically, thus allowing users passage to the secured side.

During emergencies the barriers automatically retract upward, thereby avoid users being trapped. A battery for power outage safety can be installed for retracting the barrier automatically.

FBL4200 provides both security and convenient space, all in a very durable and elegant compact design.

Features

Reliability

- SUS304 stainless steel casework ensure long-lasting durability.
- High quality electrical components.

Safety Features

- Barriers retract automatically during emergencies.
- Barriers retract automatically during power outage with battery installed.
- All smooth finishing. No exposed screws.
- Ergonomic design makes card and fingerprint authentication fast & simple for users.

Built-in Reader Integration

- FBL4200 series is already integrated with our customers' preference for either card or fingerprint access control reader. This greatly reduces installation time & expense.
- FBL4200 series and associated access control readers are all factory-tested prior to shipping.
- ZKTeco provides true plug&play turnstiles with the lowest possible total cost of ownership in the industry.

Simplification

- LCD on the flap barrier control board, easy operation.

Specifications

Power requirements	AC 100 ~ 120V/200 ~ 240V, 50/60Hz	
Working temperature	-28°C~60°C	
Working humidity	5%~80%	
Working environment	Indoor/outdoor (if sheltered)	
Speed of throughput	RFID	Maximum 30/ minute
	Fingerprint	Maximum 25/ minute
Lane width(mm)	600	
Footprint(mm*mm)	1350*840	
Dimensions(mm)	L=1350,W=300,H=1010	
Dimension with packing(mm)	L=1500,W=400,H=1100	
Net weight(kg)	84	
Weight with packing(kg)	119	
LED indicator	Y	
Cabinet material	SUS304 Stainless Steel	
Lid material	SUS304 Stainless Steel	
Barrier material	Acrylic	
Barrier movement	Retracting	
Emergency mode	Y	
Security level	Medium	
MCBF	2 million	

Dimensions (mm)

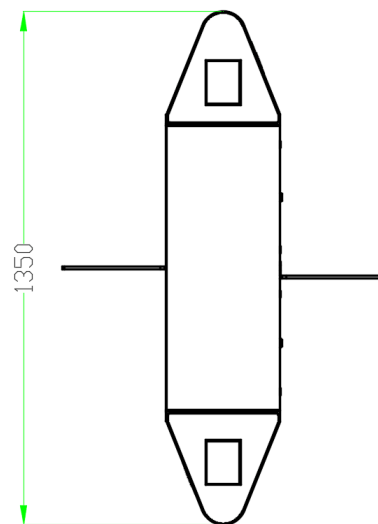
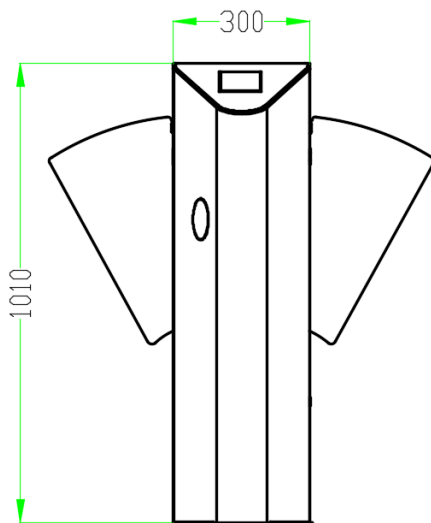

V1.1 2018.09.03